



# PIPELINE ROTARY CONTROL VALVES

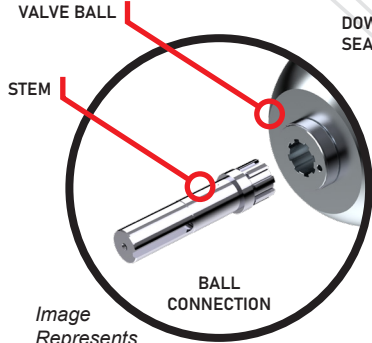
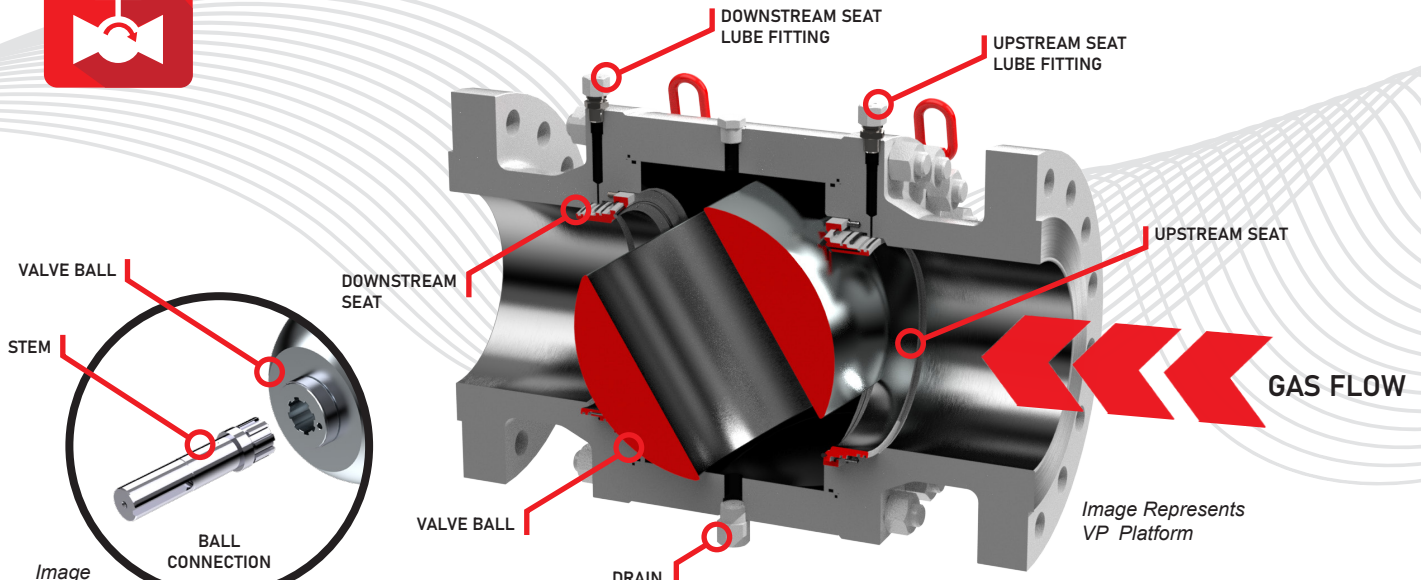
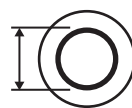

Image Represents VP Platform



SIZE RANGE  
2 in to 42 in



MAX NOISE  
ATTENUATION  
N/A



MAX RANGE-ABILITY  
100:1

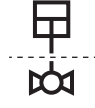

BELOW  
GROUND



ABOVE  
GROUND

## PRCV-FP

### SPECS AND MATERIALS CONSTRUCTION

Size Range	2 in to 42 in
Max Noise Attenuation	N/A
Relative Capacity	Maximum Capacity
Max Range-Ability	100:1
Shutoff	API 6D Bubble Tight

Design Standard	API-6D <sup>1,2,3,4,5,6,7</sup> ASME 16.34 <sup>8</sup> , API 6FA <sup>1,2,8</sup>
Face-Face Dimensions	API-6D
Flange Dimensions	ASME B16.5
PED / ATEX / CE	Optional <sup>8</sup>
ANSI Range	150 – 1500 ANSI
End Connections	RFFE, Weld, RTJ, Combo
Trim Type	Full Port
Performance Trim Technology	N/A
Max Control ΔP	FULL ANSI ΔP - Limit by Noise
Max Shutoff ΔP	FULL ANSI ΔP
Compatible Buried Applications	YES
Flow Profile Curve	Modified Equal Percentage
Min Control Cv	1.0% Max Cv
Max Control Cv	90% Max Cv
Seats	2X Seats Soft Seats Std Double Piston Effect <sup>2,3,4,5,6,7,8</sup> Metal Seats Optional <sup>8</sup>
Compatible Actuators	VRG RHPA-DA VRG RHPA-SR Electric Actuators Electro-Hydraulic Actuators Other Manufacturers

Base Platform	T31 / 54 / 55 / B5 / EC / EB / VP
Control Valve Specs	Per VRG PRCV Specifications
Body (Forged)	A350 LF2 <sup>3,4,5,6,7,8</sup>
Stem	AISI 4140 + 1.0 mil ENP <sup>1,2,3,4,5,6,7</sup> 174-PH SS <sup>8</sup>
Ball	A350 LF2 + 1.0 mil ENP <sup>1,2,3,4,5,6,7</sup> ASTM A694-F60 + 3.0 mil ENP <sup>8</sup> Optional SS <sup>8</sup> PRCV Control Specification
Lubrication	Mobil SHC220 OR Valtex 2000
Stem Seal	VITON O-RINGS <sup>2,3,4,5,6,7</sup> , LIP SEAL <sup>1,2</sup> PTFE V-PACK <sup>8</sup>
Stem Injection	Stem Inject & Opposing Stem Relief <sup>1,2,3,4,5,6,7,8</sup>
Body Drain	45° From Stem <sup>1,2</sup> , 90° From Stem <sup>3,4,5,6,7,8</sup>
Seat Ring	A350 LF2 + ENP <sup>1,2,3,4,5,6,7,8</sup> , Optional SS <sup>8</sup> VRG Spec Seat Springs <sup>3,4,5,6,7,8</sup>

MATERIALS OF CONSTRUCTION	
Seat Seal	VITON O-Ring Insert <sup>3,4,5,6,7</sup> DELTRIN Molded Profiled Insert <sup>8</sup> NYLON Molded Insert <sup>1,2</sup> , Optional SS <sup>8</sup>
Seat Injection	Upstream/Downstream Buttonhead <sup>1,2,3,4,5,6,7,8</sup> Body Lubrication Port <sup>3</sup>
O-Rings	VITON GLD <sup>1,2,3,4,5,6,7,8</sup>
Firesafe Seals	GRAPHITE <sup>8</sup>
High Performance Trim	N/A
Final Assembly and Test	USA & ITALY
Country Origin	USA <sup>1,2</sup> , ITALY <sup>3,4,5,6,7,8</sup> , CHINA <sup>3,4</sup>

- 1 - Applies to Type T31 Platform
- 2 - Applies to Type T32 Platform
- 3 - Applies to Type 54 Platform
- 4 - Applies to Type 55 Platform

- 5 - Applies to Type B5 Platform
- 6 - Applies to Type EC Platform
- 7 - Applies to Type EB Platform
- 8 - Applies to Type VP Platform



## CV PROFILE

### PERCENT TRAVEL

PRCV-FP	MIN	5	10	20	30	40	50	60	70	80	90	100
<b>Cv Factor</b>	0.01	0	0.008	0.042	0.081	0.129	0.190	0.280	0.447	0.690	0.861	1.000
<b>2</b>	2.6	0	2	11	21	33	50	73	116	180	224	260
<b>3</b>	5.5	0	5	23	44	71	105	154	246	380	474	550
<b>4</b>	9.75	0	8	41	79	125	186	273	436	673	839	975
<b>6</b>	26	0	21	108	209	334	495	728	1161	1795	2238	2600
<b>8</b>	52.5	0	43	219	423	675	1000	1470	2345	3625	4520	5250
<b>10</b>	85	0	70	355	685	1093	1619	2380	3797	5869	7318	8500
<b>12</b>	139	0	114	580	1120	1787	2648	3892	6209	9598	11967	13900
<b>16</b>	225	0	184	939	1813	2893	4286	6300	10050	15536	19371	22500
<b>20</b>	388	0	318	1619	3126	4989	7390	10864	17331	26790	33405	38800
<b>24</b>	580	0	475	2419	4673	7457	11048	16240	25907	40048	49935	58000
<b>30</b>	980	0	803	4088	7896	12600	18667	27440	43773	67667	84373	98000
<b>36</b>	1540	0	1261	6424	12408	19800	29333	43120	68787	106333	132587	154000
<b>Xt</b>	0.64	0.64	0.64	0.64	0.635	0.625	0.61	0.58	0.538	0.455	0.335	0.1625
<b>FI</b>	0.78	0.75	0.78	0.85	0.9	0.91	0.9	0.86	0.79	0.71	0.63	0.53

### Cv PROFILE - PRCV-FP

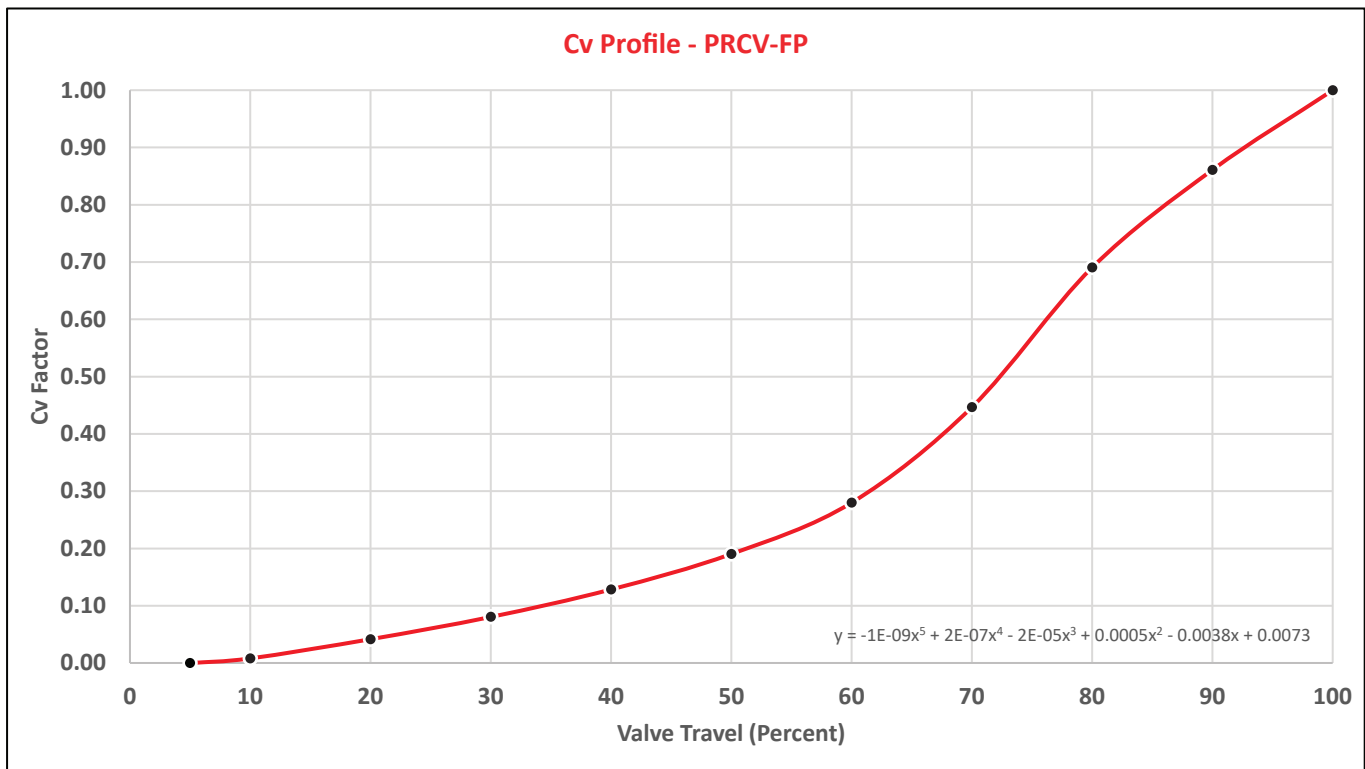



## NOISE ATTENUATION (DBA)

Noise Attenuation (dBA) vs. Rotation of PRCV Control Valve

Percent Rotation	0	5	10	20	30	40	50	60	70	80	90	100
PRCV-FP		0.0	0.0	0.0	0.0	0.0	0.0	0.0	0.0	0.0	0.0	0.0

Noise Attenuation (dBA) vs. Rotation of PRCV Control Valve

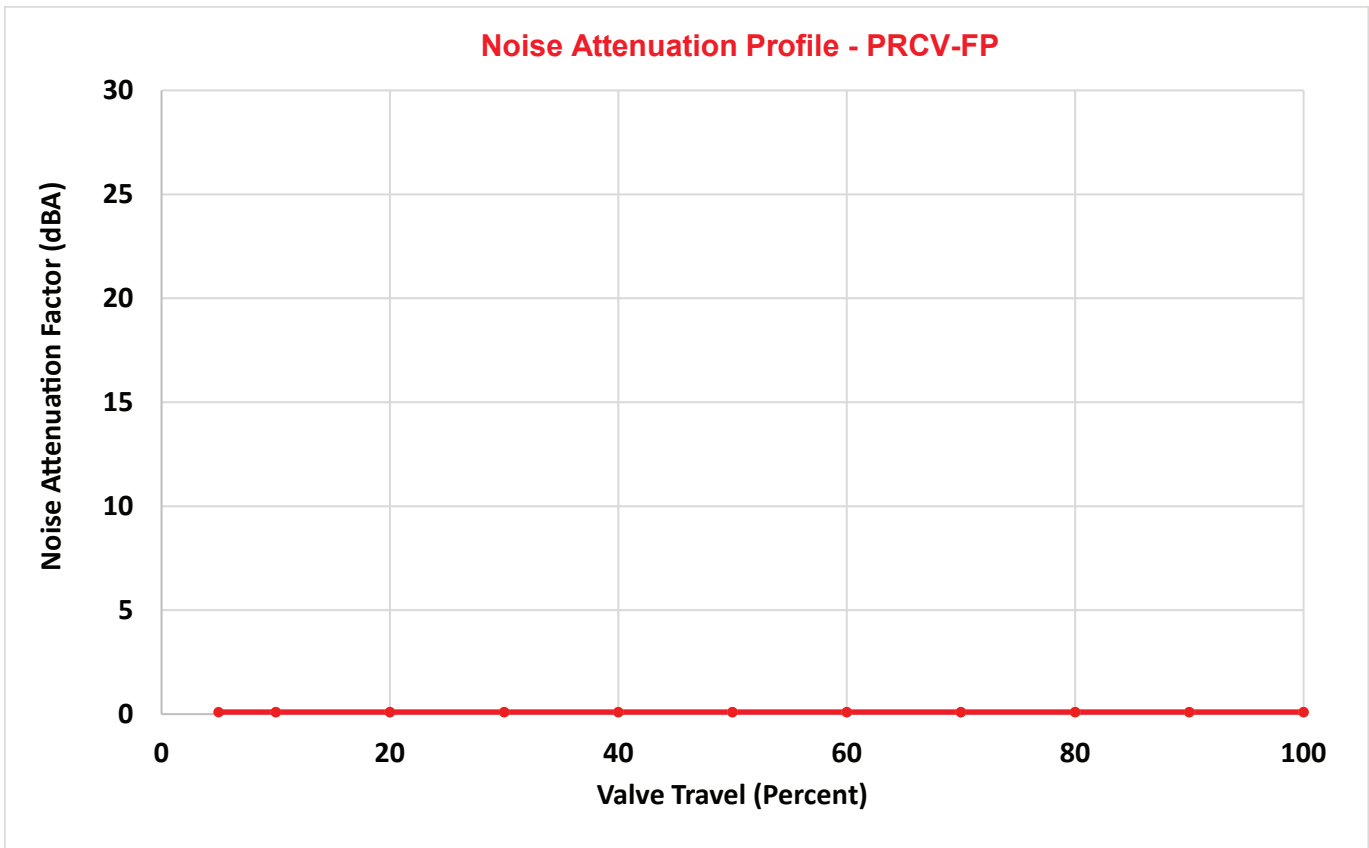



# PIPELINE ROTARY CONTROL VALVES PRCV-FP

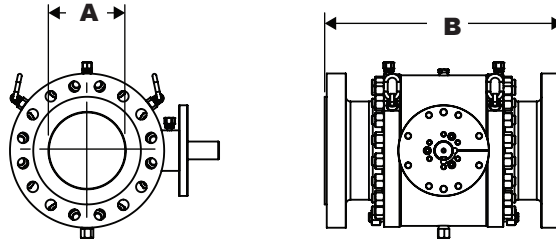

## PRCV-FP Series Face to Face Dimensions (RFFE)

A Size (Bore)		B 150 ANSI		B 300 ANSI		B 600 ANSI		B 900 ANSI		B 1500 ANSI	
Inches	(mm)	Inches	(mm)	Inches	(mm)	Inches	(mm)	Inches	(mm)	Inches	(mm)
2"	50	7	178	8.5	216	11.5	292	14.5	368	14.5	368
3"	80	8	203	11.125	283	14	356	15	381	18.5	470
4"	100	9	229	12	305	17	432	18	457	21.5	546
6"	150	15.5	394	15.875	403	22	559	24	610	27.75	705
8"	200	18	457	19.75	502	26	660	29	737	32.75	832
10"	250	21	533	22.375	568	31	787	33	838	39	991
12"	300	24	610	25.5	648	33	838	38	965	44.5	1130
16"	400	30	762	33	838	39	991	44.5	1130	54.5	1384
20"	500	36	914	39	991	47	1194	52	1321	65.5	1664
24"	600	42	1067	45	1143	55	1397	61	1549	76.5	1943
30"	750	51	1295	55	1397	65	1651	0	0	0	0
36"	900	60	1524	68	1727	82	2083	0	0	0	0

## PRCV-FP Series Standard Weights (RFFE) - T31, T32, 54, 55, EC, EB PLATFORMS

Size (Bore)		150 ANSI		300 ANSI		600 ANSI		900 ANSI		1500 ANSI	
in	mm	Lbs.	kg	Lbs.	kg	Lbs.	kg	Lbs.	kg	Lbs.	kg
2"	50	44	20	47	21	58	26	128	58	128	58
3"	80	88	40	113	51	126	57	184	83	214	97
4"	100	139	63	166	75	166	75	358	162	366	166
6"	150	386	175	430	195	541	245	717	325	1,028	466
8"	200	684	310	739	335	1004	455	1,054	478	1,482	672
10"	250	871	395	1,092	495	1,259	571	1,967	892	2,408	1092
12"	300	1,401	635	1,425	646	1,912	867	2,519	1143	3,385	1535
16"	400	2,086	946	2,585	1173	3,198	1451	4,097	1858	9,919	4499
20"	500	4,040	1833	4,869	2209	5,839	2649	6,968	3161	18743	8502
24"	600	7,934	3599	7,736	3509	8,820	4001	11,224	5091	0	0
30"	750	11859	5379	9813	4451	15413	6991	0	0	0	0
36"	900	18522	8401	17662	8011	24100	10932	0	0	0	0

## PRCV-FP Series Standard Weights (RFFE) - VP PLATFORM

Size (Bore)		150 ANSI		300 ANSI		600 ANSI		900 ANSI		1500 ANSI	
in	mm	Lbs.	kg	Lbs.	kg	Lbs.	kg	Lbs.	kg	Lbs.	kg
2"	50	66	30	68	31	93	42	130	59	132	60
3"	80	75	34	123	56	154	70	187	85	247	112
4"	100	150	68	195	88.6	320	145	370	168	399	181
6"	150	395	179	437	198	613	278	794	360	1069	485
8"	200	646	293	750	340	1041	472	1411	640	1808	820
10"	250	1036	470	1138	516	1601	726	2187	992	3571	1620
12"	300	1532	695	1720	780	2612	1185	3199	1451	5198	2358
16"	400	2657	1205	3263	1480	4279	1941	5038	2285	9943	4510
20"	500	4641	2105	5049	2290	7011	3180	9612	4360	14947	6780
24"	600	7055	3200	8516	3863	12456	5650	15498	7030	25463	11550
30"	750	11839	5370	15719	7130	18872	8560	27425	12440	0	0
36"	900	19577	8880	22531	10220	29829	13530	44423	20150	0	0